



3" & 4" GripLoc™ Compression Coupling Installation Instructions

GLCC-3A-0416

EASY INSTALLATION

Spears® GripLoc™ Compression Couplings easily install by simply sliding nut over pipe, slip on components in order shown, then insert into body and tighten nuts.

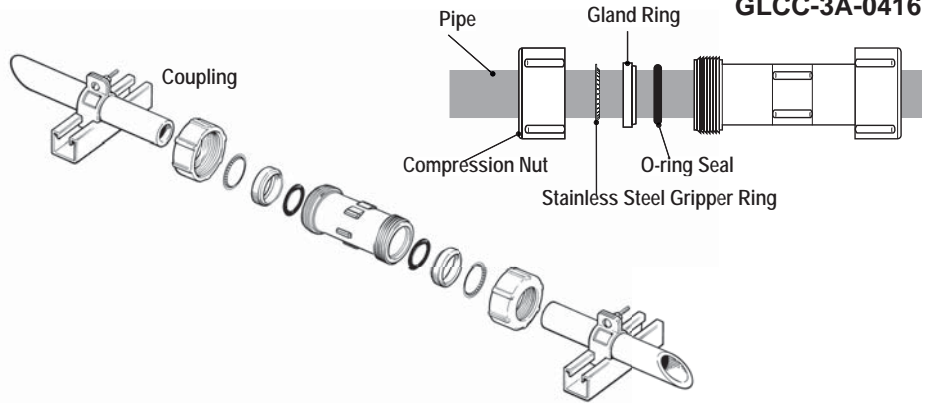

STEP 1 Cut pipe square. Deburr & bevel.

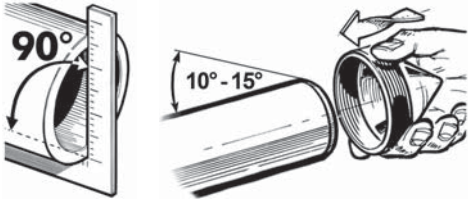

STEP 2 Install Compression Nut.

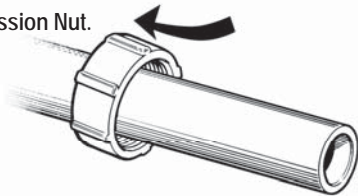

STEP 3 Install Grip-per Ring approximately 1" from pipe end.

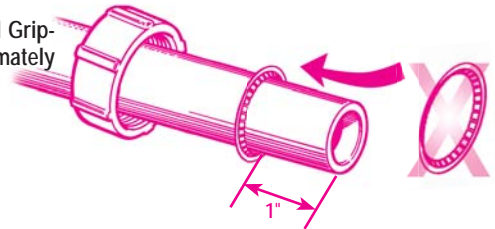

STEP 4 Install Gland Ring. Use Gland Ring to slide Gripper Ring down approximately 2" - 2-1/2".

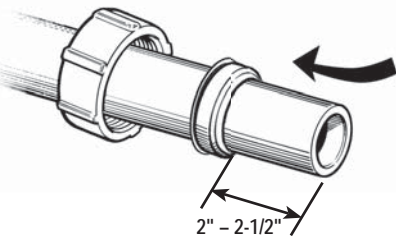

STEP 5 Install O-Ring. Slide O-ring down next to Gland Ring.

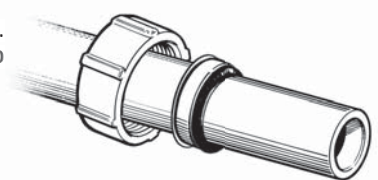

STEP 6

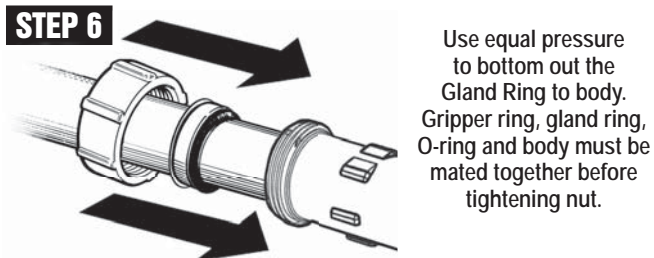

Use equal pressure to bottom out the Gland Ring to body. Gripper ring, gland ring, O-ring and body must be mated together before tightening nut.

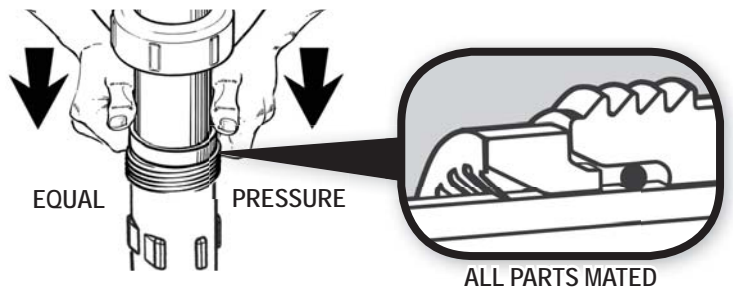

STEP 7 Lubricate Nut & Threads with a small amount of water.

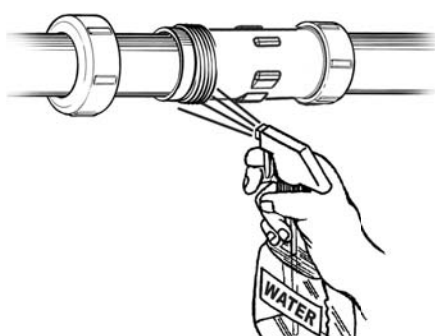

STEP 8 Screw on nut finger tight, then push pipe in until it bottoms out in body.

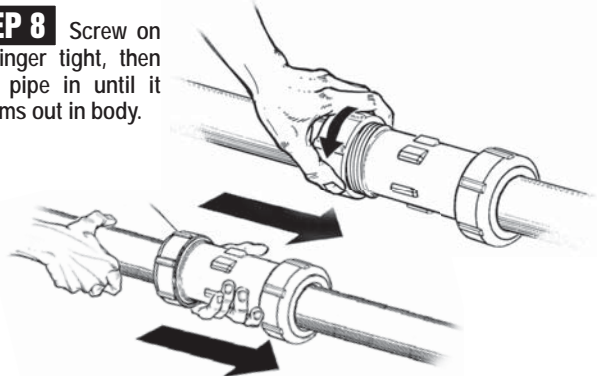

STEP 9 Hand Tighten only Compression Nut. DO NOT use Compression Coupling Nut Wrench or Strap Wrench. Additional tightening is not required to seal.

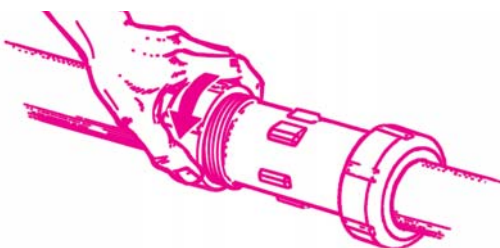

WARNING: DO NOT INSERT FINGERS. ENSURE THAT PIPE AND FITTINGS ARE FREE OF DIRT AND DEBRIS PRIOR TO INSTALLATION.



SPEARS® MANUFACTURING COMPANY CORPORATE OFFICE
15853 Olden Street, Sylmar, CA 91342 • PO Box 9203, Sylmar, CA 91392
(818) 364-1611 • www.spearsmfg.com





Instrucciones de Instalación de 3" & 4" CONEXIONES DE COMPRESIÓN GripLoc™

GLCC-3A-0416

INSTALACIÓN FÁCIL

Los acoples de compresión GripLoc™ de Spears® se instalan fácilmente al deslizar simplemente la tuerca sobre la tubería, y poniendo los componentes en el orden mostrado, después introduzca en el cuerpo y apriete las tuercas.

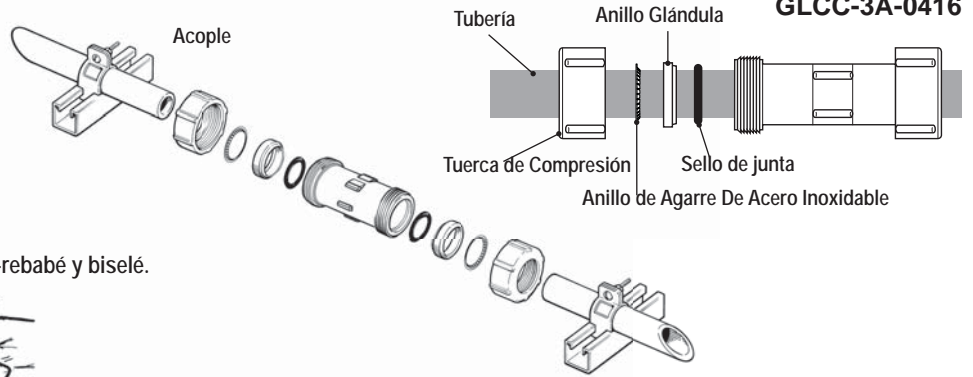

PASO 1 Corté la tubería a escuadra. Des-rebabé y biselé.

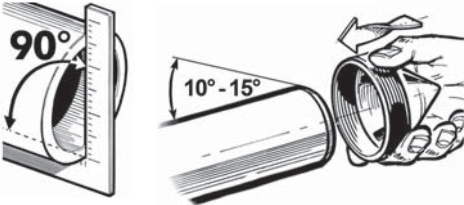

PASO 2 Instale la tuerca de compresión.

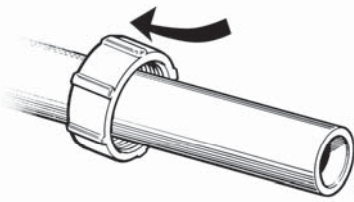

PASO 3 Instale el anillo de agarre aproximadamente a 1" del extremo del tubo.

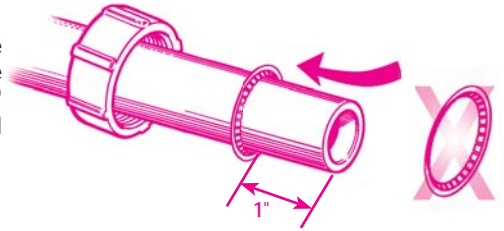

PASO 4 Instale el anillo Glándula. Use el anillo Glándula para deslizar abajo el anillo de agarre aproximadamente 2" - 2-1/2".

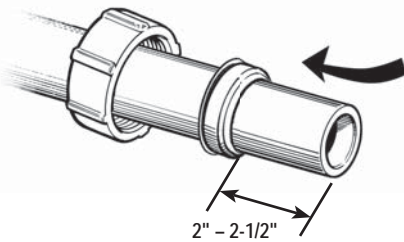

PASO 5 Instale el anillo. Deslice el anillo abajo junto al anillo Glándula.

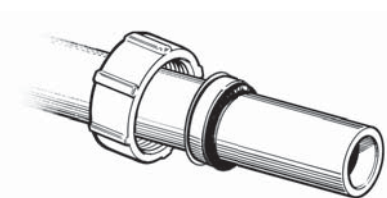

PASO 6

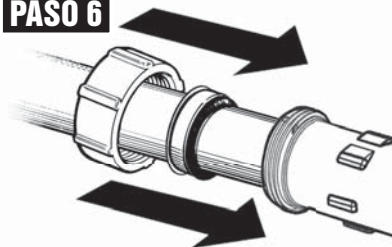

Use una presión igual para llevar al fondo el anillo Glándula al cuerpo. El anillo de agarre, el anillo Glándula, el anillo y cuerpo deben Juntarse antes de apretar la tuerca.

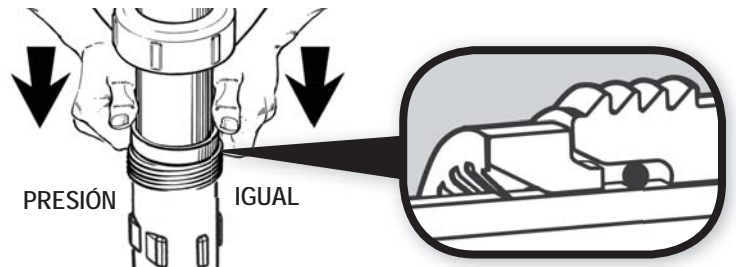

PRESIÓN IGUAL

TODAS LAS PARTES JUNTAS

PASO 7 Lubrique tuerca y roscas con un poco de agua.

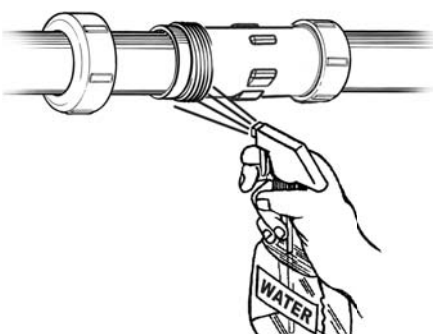

PASO 8 Enrosque la tuerca apretada con los dedos despues empuje el tubo hasta el fondo del cuerpo.

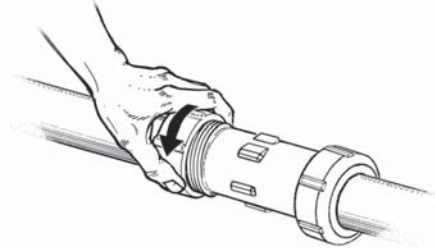

PASO 9 Apriete con la mano la tuerca de compresión. NO use llave o cincho en la tuerca del acople. No necesita un apriete adicional para sellar.

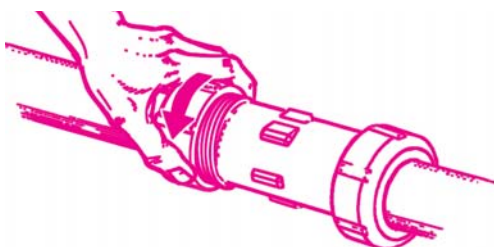

ADVERTENCIA: NO INTRODUZCA LOS DEDOS. ASEGURESE DE QUE EL TUBO Y LAS CONEXIONES ESTÉN LIBRES DE SUCIEDAD Y DESECHOS ANTES DE INSTALAR.



SPEARS® MANUFACTURING COMPANY CORPORATE OFFICE
15853 Olden Street, Sylmar, CA 91342 • PO Box 9203, Sylmar, CA 91392
(818) 364-1611 • www.spearsmfg.com

